

SERIES 120

VERNIER CALIPER

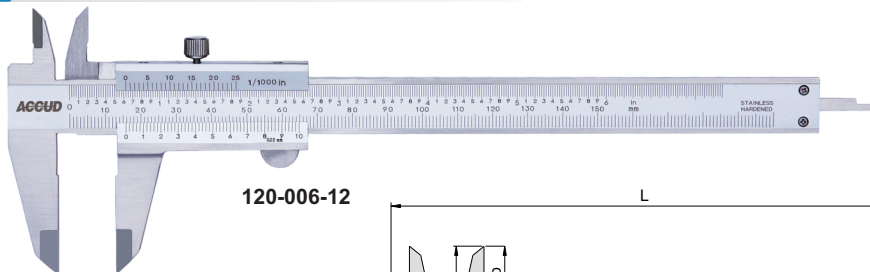

120-006-12

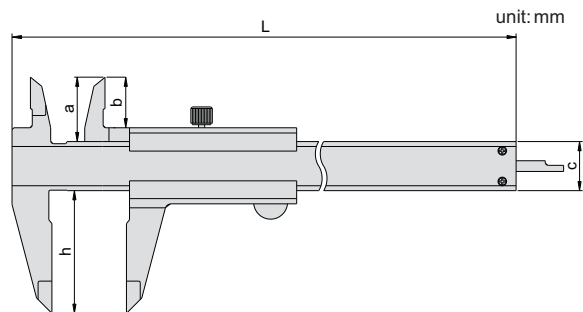

- ◆ Meet DIN862
- ◆ Satin chrome plated reading surface
- ◆ Made of stainless steel

Graduation 0.02mm/0.001"

Code	Range	Accuracy	a	b	c	h	L
120-006-12	0-150mm/0-6"	±0.03mm	20.5	15.5	16	40	235
120-008-12	0-200mm/0-8"	±0.03mm	23.5	19	16	50	290
120-012-12	0-300mm/0-12"	±0.03mm	27.5	22	20	64	414

Graduation 0.05mm/1/128"

Code	Range	Accuracy	a	b	c	h	L
120-006-14	0-150mm/0-6"	±0.05mm	20.5	15.5	16	40	235
120-008-14	0-200mm/0-8"	±0.05mm	23.5	19	16	50	290
120-012-14	0-300mm/0-12"	±0.05mm	27.5	22	20	64	414

