

DIGITAL CALIPER WITH INTERCHANGEABLE POINTS

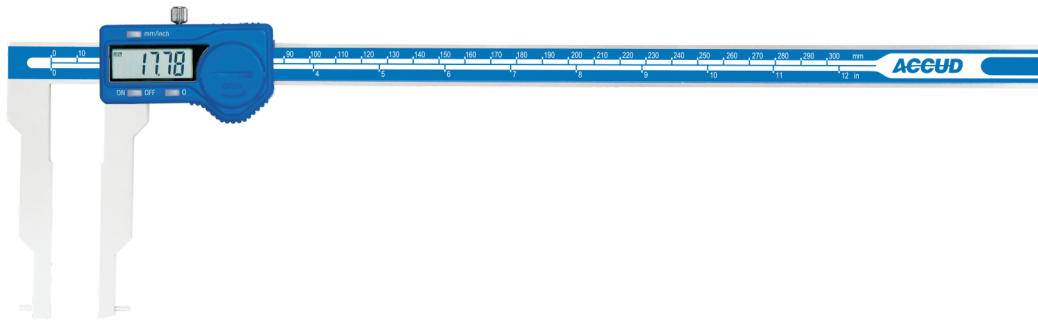

- ◆ Supplied with 4 pairs of points and one zero setting block for external measurement
- ◆ Resolution: 0.01mm/0.0005"
- ◆ Buttons: on/off, zero, mm/inch
- ◆ Automatic power on/off
- ◆ Data output(cable code: 100-11 or 100-12)
- ◆ Made of stainless steel

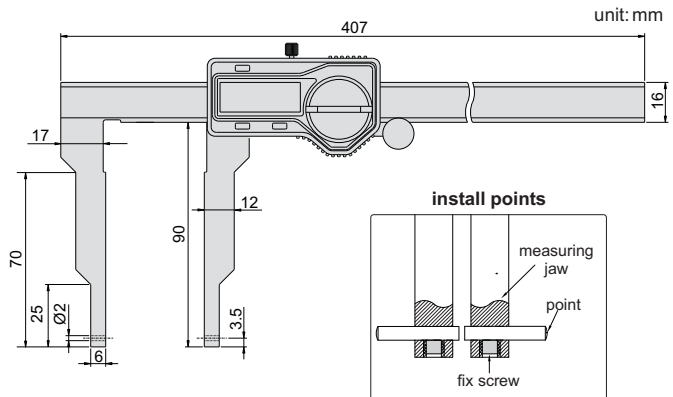

short spherical/flat points

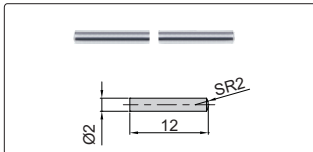

short spherical blade points

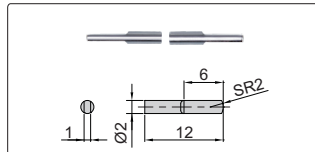

long spherical/flat points

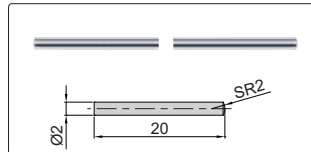

long spherical blade points

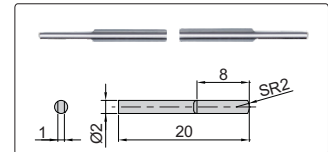

zero setting block for external measurement (included)



Measure internal and external grooves

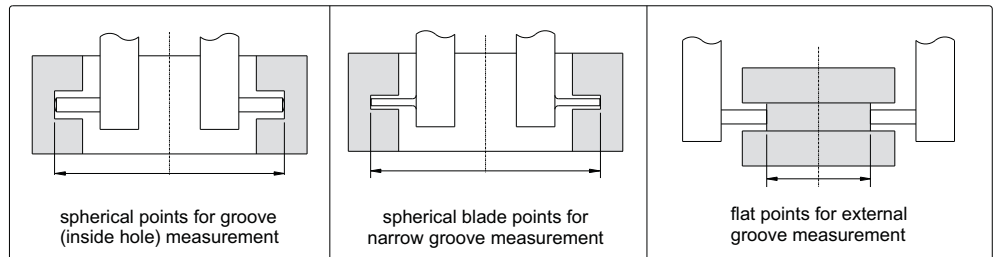

Code	Point	Range	Accuracy	Application
149-012-11	short spherical/flat points	24-324mm/1-12.7"(internal) 0-288mm/0-11.3"(external)	±0.04mm	spherical points for grooves/inside hole, (small hole) flat points for external grooves
	long spherical/flat points	40-340mm/1.5-13.3"(internal) 0-272mm/0-10.7"(external)	±0.04mm	spherical points for grooves/inside hole, (large hole) flat points for external grooves
	short spherical blade points	24-324mm/1-12.7"(internal) 0-288mm/0-11.3"(external)	±0.04mm	for narrow grooves (small hole)
	long spherical blade points	40-340mm/1.5-13.3"(internal) 0-272mm/0-10.7"(external)	±0.04mm	for narrow grooves (large hole)