

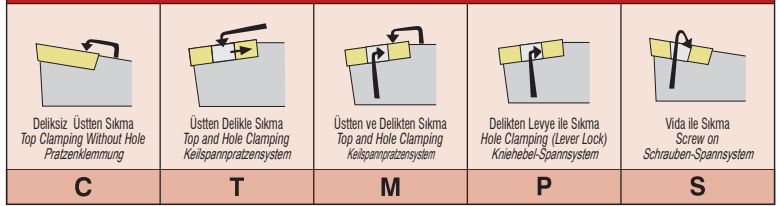

1 Sıkma Tipi / Method of Mounting of Insert / Klemmsystem

**P** **S** **K** **N** **R**

1 2 3 4 5



2 Uç Tipi / Type of Insert / Plattenform

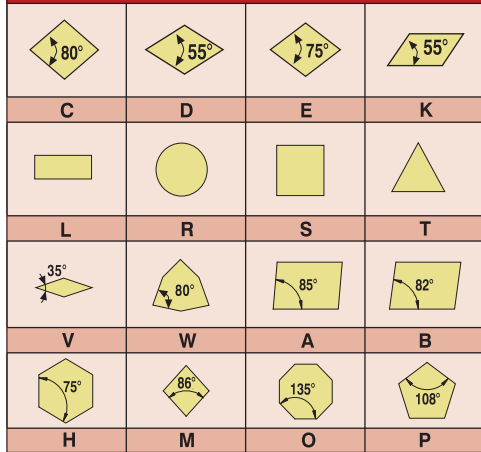

3 Yanaşma Açısı / Tool Holder Shape Bar Geometry / Anstellwinkel

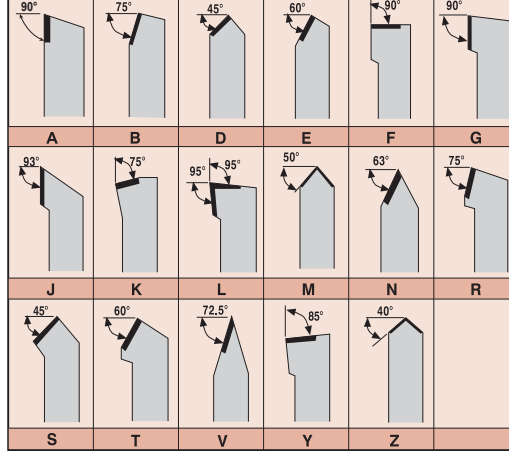

4 Serbest Uç Açısı / Insert Clearance Angle / Freiwinkel / Freiwinkel

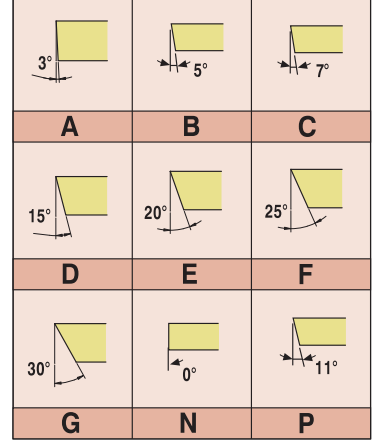

**25** **25 -** **M** **12** **C**

6 7 8 9 10

5 Kesme Yönü / Cutting Direction / Halterausführung

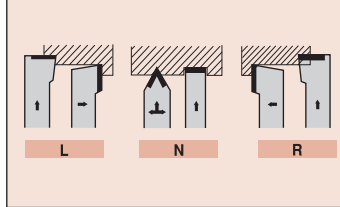

6 Kesme Kenar Yüksekliği / Cutting Edge Height / Schalthöhe

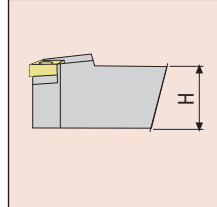

7 Şaft Geniştirliği / Shank Width / Schaftbreite

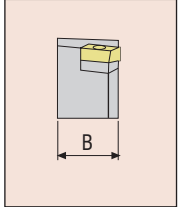

8 Şaft Boyu / Shank Length / Schaftlänge

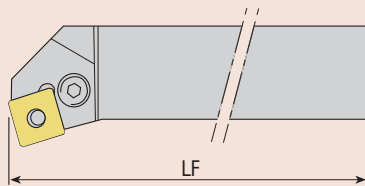

A - 32	H - 100	Q - 180	x-special
B - 40	J - 110	R - 200	
C - 50	K - 125	S - 250	
D - 60	L - 140	T - 300	
E - 70	M - 150	U - 350	
F - 80	N - 160	V - 400	
G - 90	P - 170	W - 450	

9 Kesme Kenar Uzunluğu / Cutting Edge Length / Schneidkantenlänge

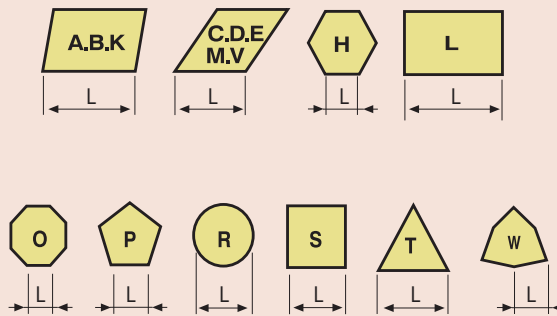

10 Baskı Pabucu / Wedge Clamp / Spannpratze

