





Takım Kodu Ordering Code Bestell-Bezeichnung	Stok Stock Lager	Takım Ölçüleri (mm) Dimension (mm) Abmessung (mm)					Kesici Uç Insert Wendeschneidplatte	Yedek Parçaları / Spare Parts / Ersatzteile		
		DCX	ZEPF	DCON	LF	APMX		Sıkma Vidası Screw Schraube	Tork Anahtar Torx Key Torx-Schlüssel	Montaj Vidası Mounting Screw Befestigungsschraube
new AFMR-RP1204M-D042-A16-Z04-H	●	42	4	16	40	6				2406-M8x30
AFMR-RP1204M-D050-A22-Z04-H	●	50	4	22	50	6				2508-M10x30
AFMR-RP1204M-D052-A22-Z05-H	●	52	5	22	50	6				2508-M10x30
AFMR-RP1204M-D063-A22-Z05-H	●	63	5	22	50	6				2508-M10x30
AFMR-RP1204M-D080-A27-Z06-H	●	80	6	27	50	6				2510-M12x35

MTSBH Ucuna Uygundur. / Compatible with MTSBH Insert. / Kompatibel mit MTSBH Wendeplatten.

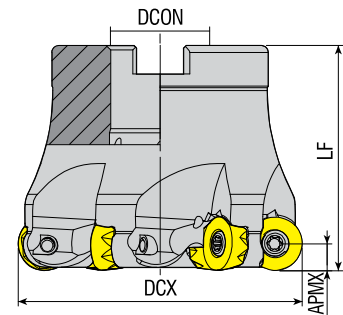

Takım Kodu Ordering Code Bestell-Bezeichnung	Stok Stock Lager	Takım Ölçüleri (mm) Dimension (mm) Abmessung (mm)					Kesici Uç Insert Wendeschneidplatte	Yedek Parçaları / Spare Parts / Ersatzteile		
		DCX	ZEPF	DCON	LF	APMX		Sıkma Vidası Screw Schraube	Tork Anahtar Torx Key Torx-Schlüssel	Montaj Vidası Mounting Screw Befestigungsschraube
AFMR-RY10-D040-A16-Z04-H	●	40	4	16	40	5				2406-M8x30
AFMR-RY10-D040-A16-Z05-H	●	40	5	16	40	5				2506-M8x30
AFMR-RY10-D050-A22-Z05-H	●	50	5	22	50	5				2508-M10x30
AFMR-RY10-D063-A22-Z06-H	●	63	6	22	50	5				2508-M10x30
AFMR-RY12-D040-A16-Z04-H	●	40	4	16	40	6				2406-M8x30
AFMR-RY12-D050-A22-Z05-H	●	50	5	22	50	6	2508-M10x30			
AFMR-RY12-D052-A22-Z05-H	●	52	5	22	50	6	2508-M10x30			
AFMR-RY12-D063-A22-Z06-H	●	63	6	22	50	6	2508-M10x30			
AFMR-RY12-D080-A27-Z06-H	●	80	6	27	50	6	2510-M12x35			
AFMR-RY12-D100-A32-Z07-H	●	100	7	32	50	6	2514-M16x35			

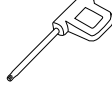
R: Sağ / Right / Rechts L: Sol / Left / Links

● Stokta / In Stock / Auf Lager ○ Stokta Yok / Non Stock Item / Kein Lagerartikel, Lieferzeit auf Anfrage

TGTC Ucuna Uygundur. / Compatible with TGTC Insert. / Kompatibel mit TGTC Wendeplatten.

Sipariş Örneği/Ordering Example/Bestellbeispiel

1 ad./pcs./stück AFMR-RP1204M-D042-A16-Z04-H

Kesme Hesabı : S 377 / Cutting Calculation : P 377 / Schnittberechnung : P 377

Montaj Ölçüleri : S 374 / Mounting Reference : P 374 / Montagehinweis : P374